

Bimetaliniai radiatoriai Aklimat M

| tipas | pajung. | aukštis | gylis | plotis | Galingumas W | | | sekcija/EUR |
|---------------|-------------|-------------|-----------|-----------|--------------|------------|------------|--------------|
| | A (mm) | B (mm) | C (mm) | D (mm) | 55/45/20 | 75/65/20 | 90/70/20 | |
| M 200 | 200 | 242 | 96 | 82 | 31 | 61 | 78 | 11,01 |
| M 350 | 350 | 392 | 96 | 82 | 46 | 90 | 115 | 13,10 |
| M 500 | 500 | 542 | 96 | 82 | 59 | 116 | 149 | 14,22 |
| M 600 | 600 | 642 | 96 | 82 | 68 | 136 | 174 | 15,60 |
| M 650 | 650 | 692 | 96 | 82 | 71 | 142 | 181 | 16,49 |
| M 900 | 900 | 942 | 96 | 82 | 90 | 180 | 232 | 21,22 |
| M 1200 | 1200 | 1242 | 96 | 82 | 110 | 224 | 289 | 29,66 |
| M 1400 | 1400 | 1442 | 96 | 82 | 123 | 252 | 325 | 35,25 |
| M 1600 | 1600 | 1642 | 96 | 82 | 137 | 279 | 359 | 40,81 |
| M 1800 | 1800 | 1842 | 96 | 82 | 150 | 305 | 393 | 44,27 |
| M 2000 | 2000 | 2042 | 96 | 82 | 163 | 330 | 425 | 47,38 |

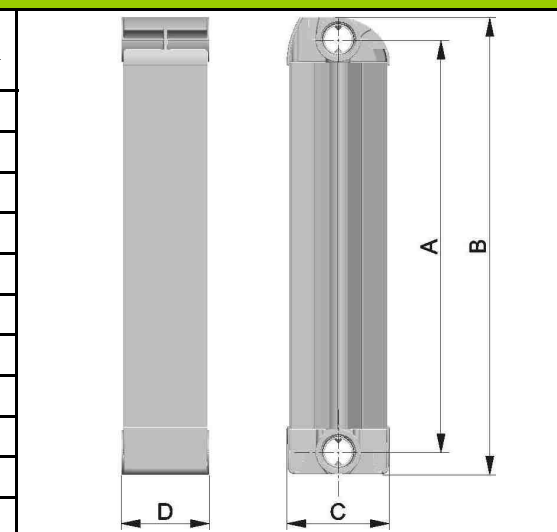

Bimetaliniai radiatoriai Aklimat T

| tipas | pajung. | aukštis | gylis | plotis | Galingumas W | | | sekcija/EUR |
|---------------|-------------|-------------|-----------|-----------|--------------|------------|------------|--------------|
| | A (mm) | B (mm) | C (mm) | D (mm) | 55/45/20 | 75/65/20 | 90/70/20 | |
| T 200 | 200 | 242 | 66 | 82 | 25 | 48 | 61 | 10,48 |
| T 350 | 350 | 392 | 66 | 82 | 36 | 71 | 90 | 12,50 |
| T 500 | 500 | 542 | 66 | 82 | 46 | 92 | 117 | 13,59 |
| T 600 | 600 | 642 | 66 | 82 | 54 | 106 | 136 | 14,92 |
| T 650 | 650 | 692 | 66 | 82 | 56 | 112 | 144 | 15,78 |
| T 900 | 900 | 942 | 66 | 82 | 75 | 151 | 194 | 16,69 |
| T 1200 | 1200 | 1242 | 66 | 82 | 96 | 195 | 251 | 18,49 |
| T 1400 | 1400 | 1442 | 66 | 82 | 109 | 223 | 287 | 20,33 |
| T 1600 | 1600 | 1642 | 66 | 82 | 123 | 249 | 321 | 28,41 |
| T 1800 | 1800 | 1842 | 66 | 82 | 136 | 275 | 355 | 33,76 |
| T 2000 | 2000 | 2042 | 66 | 82 | 148 | 301 | 387 | 39,10 |

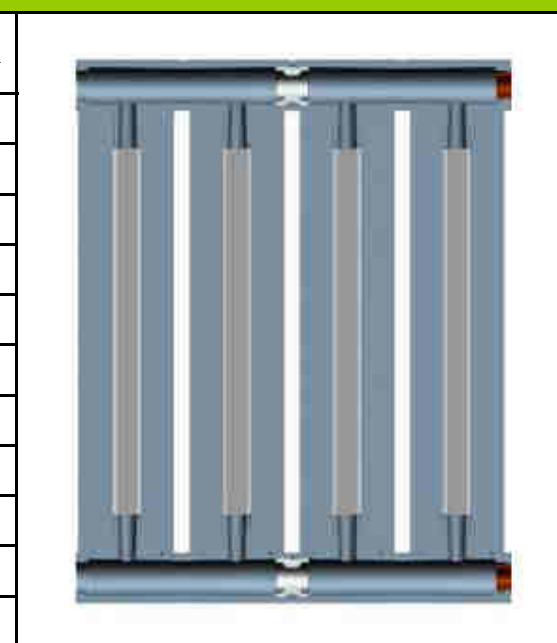

Detalesnės informacijos ir kainos teirautis: +370 5 2777750, +370 68033107, info@vilsanbaltic.lt , d.prekyba@vilsanbaltic.lt

- radiatorių aukščiai : 150, 200, 250, 300, 310, 350, 374, 380, 400, 450, 460, 500, 505, 515, 520, 524, 530, 540, 550, 570, 580, 590, 600, 650, 700, 740, 750, 800, 820, 824, 840, 845, 900, 915, 930, 950, 1000, 1024, 1030, 1100, 1200, 1300, 1400, 1500, 1600, 1700, 1800, 1900, 2000
- standartinė spalva balta (RAL 9016) , kitos spalvos pagal užsakymą + **30 %**
- radiatoriai ML , MD (apatinio pajungimo iš kairės arba dešinės pusės) radiatorių M kainomis
- **radiatoriai MV ir TV apatinio pajungimo su termoreguliatoriumi brangesni 26,00 EUR**
- **radiatoriai MM ir TM apatinio pajungimo per centrą brangesni 10,70 EUR**
- radiatorių MV, TV, MM ir TM aukštis (B): 200, 350, 500, 600, 650, 900, 1200, 1400, 1600, 1800, 2000
- radiatorių aukščių kaina kuri nenurodyta kainininke - žiūrėti sekančią poziciją
- **75/65/20** = 75 (pad. temp.), 65 (iš. temp.), 20 (kambario temp.) žemos temp. sistema = **55/45/20**



System certified to ISO 9001 in ISO 14001

3 Radiatorių šonai

| Tipas | EAN / Kodas | vnt/EUR |
|--------|------------------------|---------|
| M 200 | 3838862217727 / 593296 | 4,78 |
| M 350 | 3838862217734 / 593297 | 4,78 |
| M 500 | 3838862217741 / 593298 | 5,74 |
| M 600 | 3838862217772 / 593302 | 6,84 |
| M 650 | 3838862217789 / 593304 | 6,84 |
| M 900 | 3838862217796 / 593305 | 8,48 |
| M 1200 | 3838862217826 / 593308 | 11,35 |
| M 1400 | 3838862217840 / 593309 | 12,97 |
| M 1600 | 3838862217857 / 593310 | 14,34 |
| M 1800 | 3838862217901 / 593312 | 15,96 |
| M 2000 | 3838862217918 / 593313 | 18,02 |

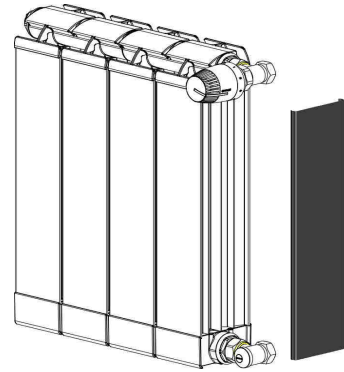

4 Aliumininiai vamzdiniai radiatoriai

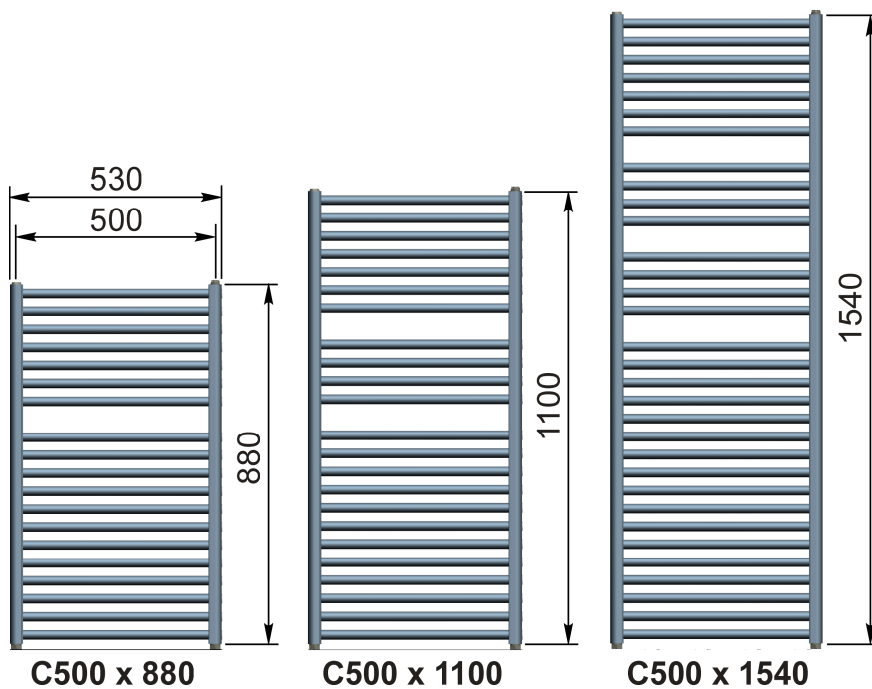

| Laikiklis rankšluoščiams L=430 | |
|---|---------|
| EAN/Kodas | EUR/vnt |
| 3838862040530 595030 | 15,35 |
|  | |
| Laikiklis | |
| EAN/Kodas | EUR/vnt |
| 3838862040547 595032 | 7,09 |
|  | |

| Tipas | EAN/Kodas | aukštis (mm) | pajungimo žingsnis (mm) | galingumas W 75/65/20°C | EUR/vnt |
|-----------|-------------------------|--------------|-------------------------|----------------------------|---------|
| C500x880 | 3838862038926 595020 | 880 | 500 | 455 | 127,44 |
| C500x1100 | 3838862038940 595022 | 1100 | 500 | 567 | 159,30 |
| C500x1540 | 3838862038964 595024 | 1540 | 500 | 752 | 197,52 |

| | Pavadinimas | Ilgis | Min. sekcijų kiekis | | EAN | Kodas | EUR/vnt |
|---|------------------|---------|---------------------|--------|---------------|--------|---------|
| | | | M, T | MV, TV | | | |
|  | el. tenas 600 W | L = 355 | 5 | 7 | 3838862040677 | 593460 | 79,06 |
| | el. tenas 900 W | L = 405 | 6 | 8 | 3838862040684 | 593461 | 81,81 |
| | el. tenas 1200 W | L = 455 | 6 | 8 | 3838862217413 | 593463 | 84,54 |
| | el. tenas 1500 W | L = 480 | 7 | 9 | 3838862040691 | 593462 | 87,27 |



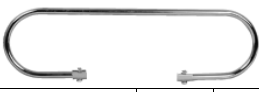

Detalesnės informacijos ir kainos teirautis: +370 5 2777750, +370 68033107, info@vilsanbaltic.lt , d.prekyba@vilsanbaltic.lt

5 Kabyklos radiatoriams ir aksesuarai













| Kabykla radiatoriui | | BALTA | EUR/vnt |
|---|---------|--------------------------------|--------------|
|  | L = 245 | 3838862313979 594086 | 10,91 |
| | L = 492 | 3838862313993 594088 | 11,20 |
| | L = 820 | 3838862314013 594090 | 11,87 |

| Vonios kabykla | | CHROMAS | EUR/vnt | BALTA | EUR/vnt |
|---|---------|--------------------------------|--------------|--------------------------------|--------------|
|  | L = 600 | 3838862014234 590443 | 27,02 | 3838862014241 590445 | 29,74 |
| | L = 530 | 3838862036694 590975 | 27,02 | 3838862036700 590976 | 29,74 |

| Kabykla | | CHROMAS | EUR/vnt | BALTA | EUR/vnt |
|---|---------|--------------------------------|--------------|--------------------------------|--------------|
|  | L = 478 | 3838862015163 590582 | 27,02 | 3838862314402 594123 | 29,74 |
| | L = 440 | 3838862025186 590855 | 26,18 | 3838862025193 590856 | 29,74 |
| | L = 360 | 3838862025216 590880 | 25,63 | 3838862025223 590881 | 29,04 |

| | | | |
|---|----------------------------|--------------------------------|--------------|
|  | Drėkintuvas M 40x19x236 mm | 3838862313917 593717 | 0,96 |
|  | Valymo šepetukas L=1000 mm | 3838862035390 102776 | 14,02 |
|  | Dažai | 3838862036526 092767 | 17,84 |
|  | Užbaigimo raktas | 3838862035963 590986 | 15,29 |

6 Prietaisai MV, MM, MD, ML, TV, TM

| Pavadinimas | | Kodas | EUR/vnt | Pavadinimas / Kodas / EAN / Matmenys | | | EUR/vnt |
|---|--|--------------------------------|--------------|--|---|--------------------------------|--------------|
|  | Tiesus pajungimo mazgas dvivamzdei sistemai | DR2 - 1/2" | 12,16 |  | WUA vožtuvas 40 radiatoriams MM ir TM dvivamzdei sistemai tiesus | 29,14 | |
| | | 3838862375700 128733 | | | | | |
|  | Kampinis pajungimo mazgas dvivamzdei sistemai | DK2 - 1/2" | 12,16 |  | WUA vožtuvas 40 radiatoriams MM ir TM vienvamzdei sistemai tiesus | 29,92 | |
| | | 3838862375717 128734 | | | | | |
|  | Tiesus pajungimo mazgas vienvamzdei sistemai | DR1 - 1/2" | 22,36 |  | WUA vožtuvas 40 radiatoriams MM ir TM dvivamzdei sistemai kampinis | 29,92 | |
| | | 3838862375748 128738 | | | | | |
|  | Kampinis pajungimo mazgas vienvamzdei sistemai | DK1 - 1/2" | 22,65 |  | WUA vožtuvas 40 radiatoriams MM ir TM vienvamzdei sistemai kampinis | 31,80 | |
| | | 3838862375724 128739 | | | | | |
|  | Universalus pajungimo mazgas | | 34,09 |  | Termogalvutė | | 20,16 |
| | U2-1/2" | 3838862375731 128740 | | | Herz | 3838862313504 128592 | |
|  | Termogalvutė | | 21,80 | Pavadinimas / EAN/ Kodas | | | EUR/vnt |
| | StarTec | 3838862217550 593201 | | | Dydis | Kodas | |
|  | Termogalvutė | | 15,44 | Tarpinė veržlė variniam vamzdžiui | | | 6,55 |
| | Aklimat | 3838862217949 516567 | | 3838862217567 128257 | f 15 | C 15 | |
| | | | | 3838862217574 128280 | f 16 | C 16 | |
| | | | | 3838862217581 128325 | f 18 | C 18 | |
| Tarpinė veržlė vamzdžiams iš propileno | | | 8,19 | 3838862217482 128304 | 16 x 2,0 | P 16 | |
| 3838862217499 128305 | 18 x 2,0 | P 18 | | | | | |
| 3838862217598 128684 | 20 x 2,0 | P 20 | | | | | |

Detalesnės informacijos ir kainos teirautis: +370 5 2777750, +370 68033107, info@vilsanbaltic.lt , d.prekyba@vilsanbaltic.lt

7 Galimi pajungimo variantai



Klasikinis pajungimas
M, T

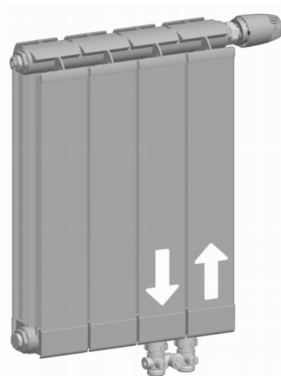

Apatinis pajungimas
MV, TV dešinė ar kairė

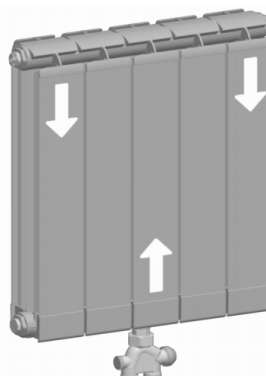



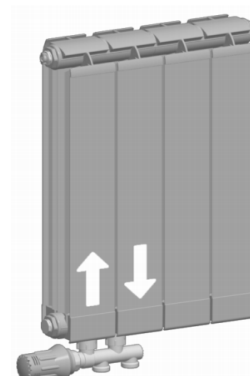



Centrinis pajungimas
MM, TM







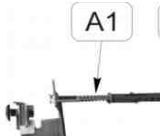

Apatinis pajungimas
MD, ML dešinė ar kairė

Pajungimo komplektas

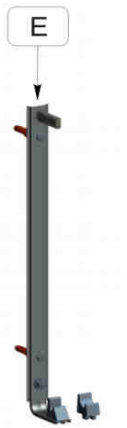
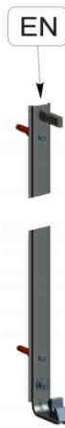
| Pavadinimas | EAN/ Kodas | EUR/komp. |
|--|--------------------------------|--------------|
|  Pajungimo komplektas radiatoriams M ir T su nuorintoju G1/2" | 3838862035932 590972 | 5,32 |
|  Pajungimo komplektas radiatoriams MD/ML ir TD/TL su nuorintoju G1/2" | 3838862040554 593242 | 5,32 |
|  Pajungimo komplektas radiatoriams M ir T vienvamzdei sistemai G1/2" | 3838862040592 593244 | 7,90 |
|  Pajungimo komplektas radiatoriams MM ir TM su nuorintoju G1/2" | 3838862040615 593246 | 8,08 |
|  Sujungimo komplektas radiatoriams | 3838862035956 590974 | 2,72 |
|  Automatinis nuorintojas G1/2" | 3838862040707 069004 | 10,97 |
|  Automatinis saugus nuorintojas 1/2" | 3838862314624 593794 | 12,11 |

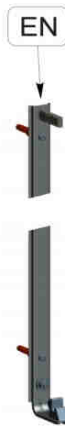
Laikikliai

| Laikiklis | EAN / Kodas | Tipas | EUR/vnt |
|--|--------------------------------|--------------|--------------|
|  A1 | 3838862029764 590904 | VISI | 1,85 |
|  D-two lane M-MS | 3838862313443 580466 | M/T 200-350 | 12,57 |
|  D-one lane M-MS | 3838862313948 580463 | M/T 200-350 | 9,44 |
|  E 350 | 3838862024257 580439 | M/T 350-450 | 2,87 |
|  E 500 | 3838862024264 580440 | M/T 500-600 | 3,28 |
|  E 650 | 3838862017259 580441 | M/T 650-850 | 3,97 |
|  E 900 | 3838862017266 580442 | M/T 900-1000 | 4,24 |
|  EN | 3838862017396 580453 | VISI | 3,97 |
|  DV for M | 3838862313450 580467 | M 500-900 | 9,44 |

Detalesnės informacijos ir kainos teirautis: +370 5 2777750, +370 68033107, info@vilsanbaltic.lt , d.prekyba@vilsanbaltic.lt