

aklimat®

Mažmeninės kainos su PVM

Kainos EUR su PVM

Radiatoriai aklimat T

tipas	pajung.	aukštis	gylis	plotis	Galingumas W			sekcija/EUR
	A (mm)	B (mm)	C (mm)	D (mm)	55/45/20	75/65/20	90/70/20	
T 200	200	242	66	82	25	48	61	9,85
T 350	350	392	66	82	36	71	90	11,29
T 500	500	542	66	82	46	92	117	11,58
T 600	600	642	66	82	54	106	136	12,45
T 650	650	692	66	82	56	112	144	13,03
T 900	900	942	66	82	75	151	194	16,50
T 1200	1200	1242	66	82	96	195	251	23,17
T 1400	1400	1442	66	82	109	223	287	27,52
T 1600	1600	1642	66	82	123	249	321	31,86
T 1800	1800	1842	66	82	136	275	355	34,17
T 2000	2000	2042	66	82	148	301	387	36,20

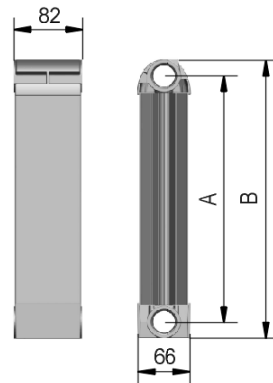

Detalesnės informacijos ir kainos teirautis: +370 5 2777750, +370 68033107, info@vilsanbaltic.lt, d.prekyba@vilsanbaltic.lt

- radiatorių aukščiai : 150, 200, 250, 300, 310, 350, 374, 380, 400, 450, 460, 500, 505, 515, 520, 524, 530, 540, 550, 570, 580, 590, 600, 650, 700, 740, 750, 800, 820, 824, 840, 845, 900, 915, 930, 950, 1000, 1024, 1030, 1100, 1200, 1300, 1400, 1500, 1600, 1700, 1800, 1900, 2000
- standartinė spalva balta (RAL 9016) , kitos spalvos pagal užsakymą + **30 %**
- radiatoriai **TV** apatinio pajungimo su termoreguliatuimi brangesni **26,00 EUR**
- radiatoriai **TM** apatinio pajungimo per centrą brangesni **10,70 EUR**
- radiatorių TV ir TM aukštis (B): 200, 350, 500, 600, 650, 900, 1200, 1400, 1600, 1800, 2000 - radiatorių aukščių kaina kuri nenurodyta kainininke - žiūrėti sekančią poziciją
- **75/65/20** = 75 (pad. temp.), 65 (iš. temp.), 20 (kambario temp.) žemos temp. sistema = **55/45/20**



ISO 9001
BUREAU VERITAS
Certification



ISO 14001
BUREAU VERITAS
Certification



3 Radiatorių šonai

Tipas	EAN / Kodas	vnt/EUR
M 200	3838862217727 / 593296	4,78
M 350	3838862217734 / 593297	4,78
M 500	3838862217741 / 593298	5,74
M 600	3838862217772 / 593302	6,84
M 650	3838862217789 / 593304	6,84
M 900	3838862217796 / 593305	8,48
M 1200	3838862217826 / 593308	11,35
M 1400	3838862217840 / 593309	12,97
M 1600	3838862217857 / 593310	14,34
M 1800	3838862217901 / 593312	15,96
M 2000	3838862217918 / 593313	18,02

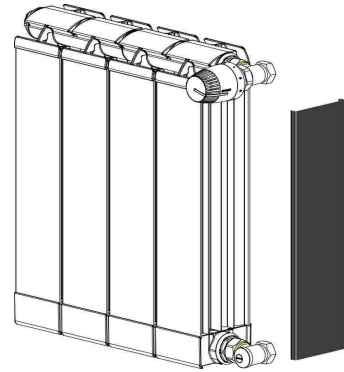

4 Aliumininiai vamzdiniai radiatoriai

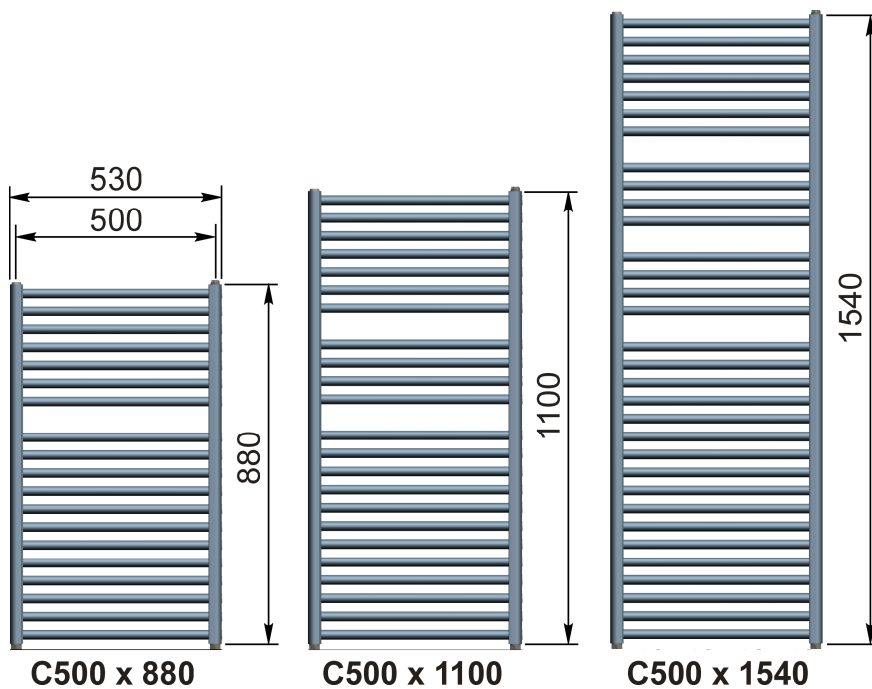

Laikiklis rankšluoščiams L=430	
EAN/Kodas	EUR/vnt
3838862040530 595030	15,35
	
Laikiklis	
EAN/Kodas	EUR/vnt
3838862040547 595032	7,09
	

Tipas	EAN/Kodas	aukštis (mm)	pajungimo žingsnis (mm)	galingumas W 75/65/20°C	EUR/vnt
C500x880	3838862038926 595020	880	500	455	127,44
C500x1100	3838862038940 595022	1100	500	567	159,30
C500x1540	3838862038964 595024	1540	500	752	197,52

	Pavadinimas	Ilgis	Min. sekcijų kiekis		EAN	Kodas	EUR/vnt
			M, T	MV, TV			
	el. tenas 600 W	L = 355	5	7	3838862040677	593460	79,06
	el. tenas 900 W	L = 405	6	8	3838862040684	593461	81,81
	el. tenas 1200 W	L = 455	6	8	3838862217413	593463	84,54
	el. tenas 1500 W	L = 480	7	9	3838862040691	593462	87,27



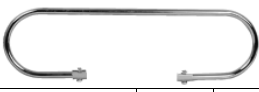

Detalesnės informacijos ir kainos teirautis: +370 5 2777750, +370 68033107, info@vilsanbaltic.lt , d.prekyba@vilsanbaltic.lt

5 Kabyklos radiatoriams ir aksesuarai













Kabykla radiatoriui		BALTA	EUR/vnt
	L = 245	3838862313979 594086	10,91
	L = 492	3838862313993 594088	11,20
	L = 820	3838862314013 594090	11,87

Vonios kabykla		CHROMAS	EUR/vnt	BALTA	EUR/vnt
	L = 600	3838862014234 590443	27,02	3838862014241 590445	29,74
	L = 530	3838862036694 590975	27,02	3838862036700 590976	29,74

Kabykla		CHROMAS	EUR/vnt	BALTA	EUR/vnt
	L = 478	3838862015163 590582	27,02	3838862314402 594123	29,74
	L = 440	3838862025186 590855	26,18	3838862025193 590856	29,74
	L = 360	3838862025216 590880	25,63	3838862025223 590881	29,04

	Drėkintuvas M 40x19x236 mm	3838862313917 593717	0,96
	Valymo šepetukas L=1000 mm	3838862035390 102776	14,02
	Dažai	3838862036526 092767	17,84
	Užbaigimo raktas	3838862035963 590986	15,29

6 Prietaisai MV, MM, MD, ML, TV, TM

Pavadinimas		Kodas	EUR/vnt	Pavadinimas / Kodas / EAN / Matmenys			EUR/vnt
	Tiesus pajungimo mazgas dvivamzdei sistemai	DR2 - 1/2"	12,16		WUA vožtuvas 40 radiatoriams MM ir TM dvivamzdei sistemai tiesus	29,14	
		3838862375700 128733					
	Kampinis pajungimo mazgas dvivamzdei sistemai	DK2 - 1/2"	12,16		WUA vožtuvas 40 radiatoriams MM ir TM vienvamzdei sistemai tiesus	29,92	
		3838862375717 128734					
	Tiesus pajungimo mazgas vienvamzdei sistemai	DR1 - 1/2"	22,36		WUA vožtuvas 40 radiatoriams MM ir TM dvivamzdei sistemai kampinis	29,92	
		3838862375748 128738					
	Kampinis pajungimo mazgas vienvamzdei sistemai	DK1 - 1/2"	22,65		WUA vožtuvas 40 radiatoriams MM ir TM vienvamzdei sistemai kampinis	31,80	
		3838862375724 128739					
	Universalus pajungimo mazgas		34,09		Termogalvutė		20,16
	U2-1/2"	3838862375731 128740			Herz	3838862313504 128592	
	Termogalvutė		21,80	Pavadinimas / EAN/ Kodas			EUR/vnt
	StarTec	3838862217550 593201			Dydis	Kodas	
	Termogalvutė		15,44	Tarpinė veržlė variniam vamzdžiui			6,55
	Aklimat	3838862217949 516567		3838862217567 128257	f 15	C 15	
				3838862217574 128280	f 16	C 16	
				3838862217581 128325	f 18	C 18	
Tarpinė veržlė vamzdžiams iš propileno			8,19	3838862217482 128304	16 x 2,0	P 16	
3838862217499 128305	18 x 2,0	P 18					
3838862217598 128684	20 x 2,0	P 20					

Detalesnės informacijos ir kainos teirautis: +370 5 2777750, +370 68033107, info@vilsanbaltic.lt , d.prekyba@vilsanbaltic.lt

7 Galimi pajungimo variantai



Klasikinis pajungimas
M, T

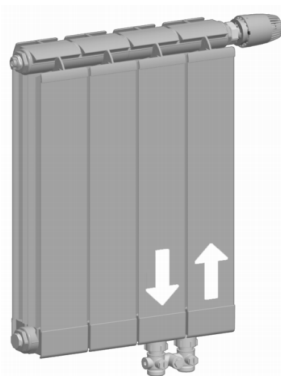

Apatinis pajungimas
MV, TV dešinė ar kairė

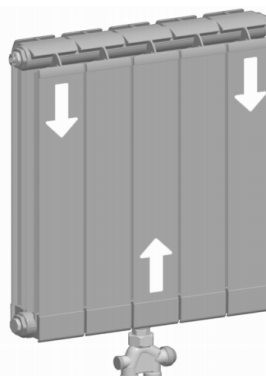



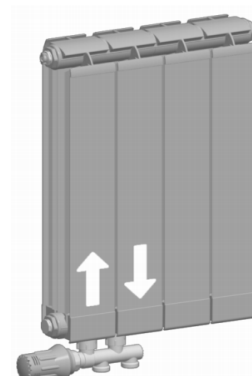



Centrinis pajungimas
MM, TM







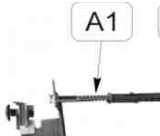

Apatinis pajungimas
MD, ML dešinė ar kairė

Pajungimo komplektas

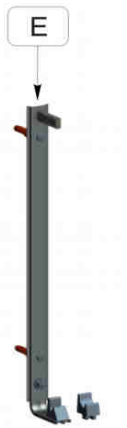
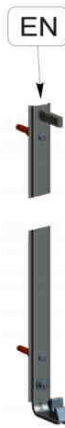
Pavadinimas	EAN/ Kodas	EUR/komp.
 Pajungimo komplektas radiatoriams M ir T su nuorintoju G1/2"	3838862035932 590972	5,32
 Pajungimo komplektas radiatoriams MD/ML ir TD/TL su nuorintoju G1/2"	3838862040554 593242	5,32
 Pajungimo komplektas radiatoriams M ir T vienvamzdei sistemai G1/2"	3838862040592 593244	7,90
 Pajungimo komplektas radiatoriams MM ir TM su nuorintoju G1/2"	3838862040615 593246	8,08
 Sujungimo komplektas radiatoriams	3838862035956 590974	2,72
 Automatinis nuorintojas G1/2"	3838862040707 069004	10,97
 Automatinis saugus nuorintojas 1/2"	3838862314624 593794	12,11

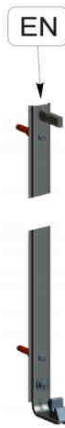
Laikikliai

Laikiklis	EAN / Kodas	Tipas	EUR/vnt
 A1	3838862029764 590904	VISI	1,85
 D-two lane M-MS	3838862313443 580466	M/T 200-350	12,57
 D-one lane M-MS	3838862313948 580463	M/T 200-350	9,44
 E 350	3838862024257 580439	M/T 350-450	2,87
 E 500	3838862024264 580440	M/T 500-600	3,28
 E 650	3838862017259 580441	M/T 650-850	3,97
 E 900	3838862017266 580442	M/T 900-1000	4,24
 EN	3838862017396 580453	VISI	3,97
 DV for M	3838862313450 580467	M 500-900	9,44

Detalesnės informacijos ir kainos teirautis: +370 5 2777750, +370 68033107, info@vilsanbaltic.lt , d.prekyba@vilsanbaltic.lt